

Ideal Workstation. 7S

SPECIFICATIONS

IWS-7-S-BA



Natural Golden Bamboo

IWS-7-S-GT



Graphite Wood Composite

IWS-7-S-WH



Designer White Resin*

IWS-7-S-GR



Exclusive Gray Resin*

Specifications

Single bowl
Users: 1-3
Culinary Tools included: Eight
Galley Taps recommended: Two
Outside dimensions: 81 1/2" x 19 1/2" x 10 5/16"
Countertop cutout: 80 1/2" x 18"
Basin area: 80" x 16"
Minimum cabinet size: 84" or 210cm

Culinary Tools included (CKT-17)

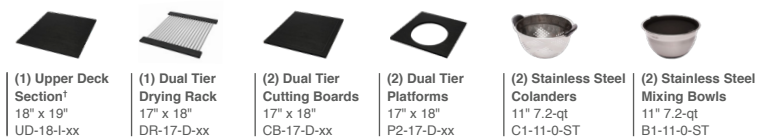

Basin (KSO-7-S-SS)

16GA 316L stainless steel indoor/outdoor
SilentArmor™ sound reduction technology
Angel finish
Two tier design
Star™ groove pattern
Reversible side drain
Drain cover included
Limited Lifetime Warranty
Made in the USA
ASME A112.19.3/CSA B45.4 certified

Personalize Your IWS-7-S

Add 7-12" length
Add 1-6" length
Add 18" DryDock
Add 12" DryDock
Apron front
9" height
Center drain
Galley Tap collection
Optional Culinary Tools
*Color coded labels available

† The Upper Deck requires a 1/4" clearance below the surface of the countertop. If the countertop thickness is 2cm or less, Bamboo Upper Deck sections will not have the needed clearance to function above the Upper Tier Culinary Tools.

Please refer to Culinary Kit Finish descriptions for planning. Custom options are available for countertops that are 1/2" or less in thickness.

Upper Deck™

Upper Deck cover set UD-7-4P-GT/BA/GR/WH Graphite, Bamboo, Gray or White Resin

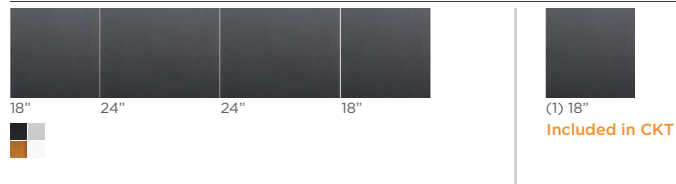

Upper Deck sections Graphite, Bamboo, Gray or White Resin



Recommended Basin Accessories

Bottom Grate set BG-7-S-3-SS Stainless Steel

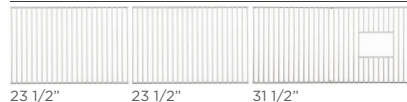

Manual Strainer Basket
M-DRN-MSS Angel Finish 304 Stainless Steel



Disposal Flange Strainer Basket
G-DRN-MSS Angel Finish 304 Stainless Steel



Auto Strainer Basket Angel Finish 304 Stainless Steel with Polished or Matte knob



A-DRN-PSS
A-DRN-MSS

A-DRN-MSS shown

Ideal Workstation. 7S

SPECIFICATIONS

Tap Hole Specifications

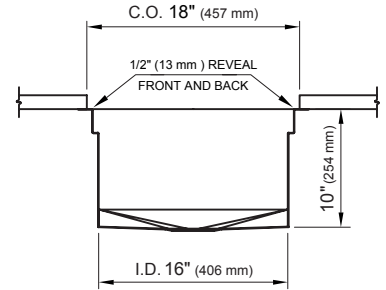
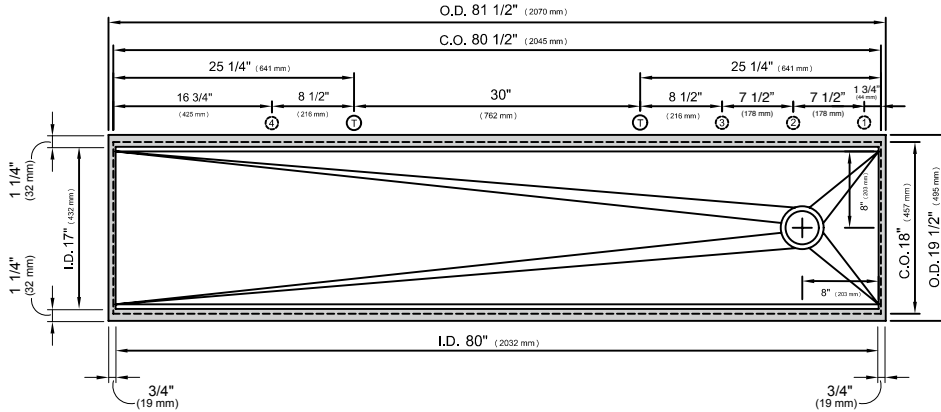

SUGGESTED GALLEY TAP AND TAP ACCESSORIES PLACEMENT GUIDE

(Recommendations are based on installing 3 or more Tap accessories. If installing a Galley Tap, Soap Dispenser, or Deck Switch only, use holes ①, ②, and ③.)

Suggested maximum inside corner radius of countertop cutout 3/8"

① Galley Tap 1 3/8" min hole diameter (1 1/2" min hole diameter for fast water jet cut)

② Galley Deck Switch 1 3/8" min hole diameter or Galley Automatic Strainer Basket knob 1" min and 1 3/8" max hole diameter

③ Galley Hot & Cold Tap 1 3/8" min hole diameter (1 1/2" min hole diameter for fast water jet cut) or Galley Air Gap 1 3/8" min hole diameter

④ Galley Soap Dispenser 1" min to 1 3/8" max hole diameter

Center Tap hole diameters 2" behind cutout

Note: Galley Hot & Cold Tap requires a minimum 8" clearance to center if installed to the right of the Galley Tap

Note: For installation where the drain is on the left side, simply reverse placements of Tap and Tap Accessories

Countertop Cutout Plan

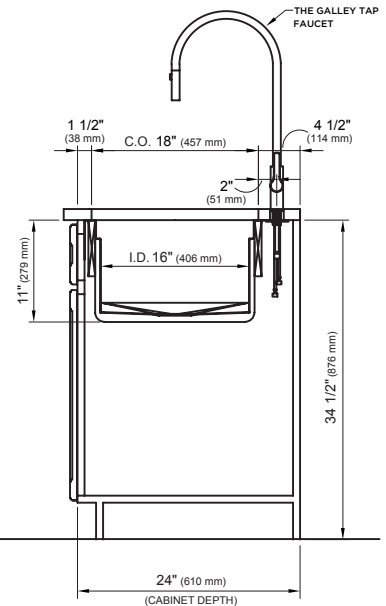
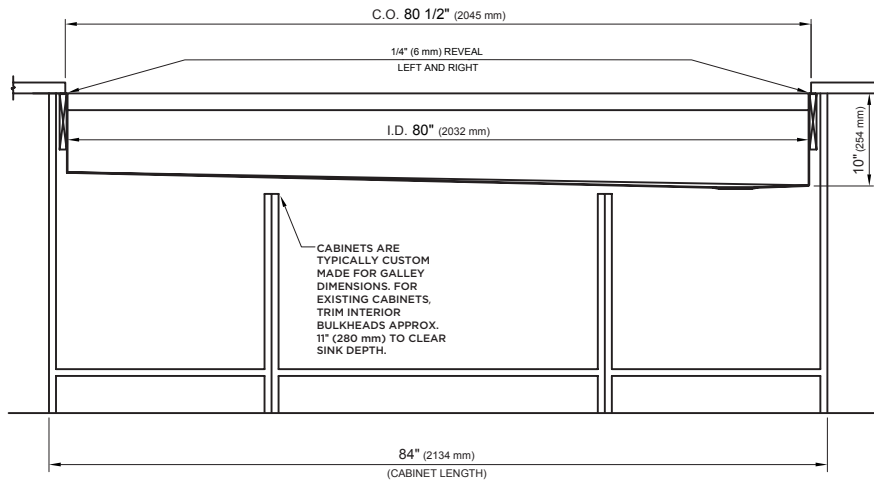

STAINLESS STEEL COMPLIANCE ASME A112. 19.3-2008/CSA B45.4-08

WE RESERVE THE RIGHT TO MAKE REVISIONS WITHOUT NOTICE IN THE DESIGN OF PRODUCTS OR IN PACKAGING UNLESS THIS RIGHT HAS SPECIFICALLY BEEN WAIVED AT THE TIME THE ORDER IS ACCEPTED.

DWG and DXF templates available on our website:

TheGalley.com/specifications

Questions? For additional assistance, please contact
The Galley's Customer Service Department at 800.375.4255