

Ideal WashStation™ 4D

SPECIFICATIONS

IWA-4-D-BA



Natural Golden Bamboo / Exclusive Gray Resin

IWA-4-D-GT



Graphite Wood Composite / Graphite Resin

IWA-4-D-WH



Designer White Resin*

IWA-4-D-GR



Exclusive Gray Resin*

Specifications

Double bowl
Users: 1
Wash Tools included: Four
Galley Tap recommended: One
Outside dimensions: 45 1/2" x 19 1/2" x 10 5/16"
Countertop cutout: 44 1/2" x 18"
Basin area: 21 7/8", 21 7/8" x 16"
Minimum cabinet size: 48" or 120cm

Basin (KSO-4-D-SS)

16GA 316L stainless steel indoor/outdoor
SilentArmor™ sound reduction technology
Angel finish
Two tier design
Star™ groove pattern
Center drains
Drain covers included
Limited Lifetime Warranty
Made in the USA
ASME A112.19.3/CSA B45.4 certified

Wash Tools included (WKT-4T)



(1) Upper Tier
Drying Rack
9 1/4" x 18"
DR-09-U-xx



(1) Lower Tier
Wash Caddy
6" x 17"
WC-06-L-xx



(1) Lower Tier
Wash Bowl
12" x 17"
WB-12-L-xx



(1) Upper Tier
Utensil Caddy
6" x 18"
UC-06-U-xx

Personalize Your IWA-4-D

Add 7-12" length
Add 1-6" length
Add 18" DryDock
Add 12" DryDock

Apron front
9" height

Galley Tap collection
Optional Culinary Tools
*Color coded labels available

Upper Deck™

Upper Deck cover set **UD-4-2P-GT/BA/GR/WH** Graphite, Bamboo, Gray or White Resin

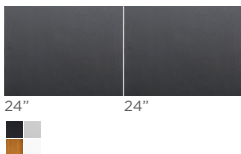

Upper Deck sections Graphite, Bamboo, Gray or White Resin

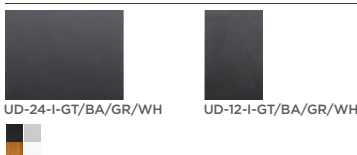

Recommended Basin Accessories

Bottom Grate set **BG-4-D-2-SS** Stainless Steel

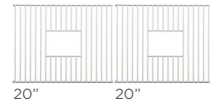

Manual Strainer Basket
M-DRN-MSS Angel Finish 304 Stainless Steel



Disposal Flange Strainer Basket
G-DRN-MSS Angel Finish 304 Stainless Steel



Auto Strainer Basket Angel Finish 304 Stainless Steel with Polished or Matte knob



A-DRN-PSS
A-DRN-MSS

Ideal WashStation™ 4D

SPECIFICATIONS

Tap Hole Specifications

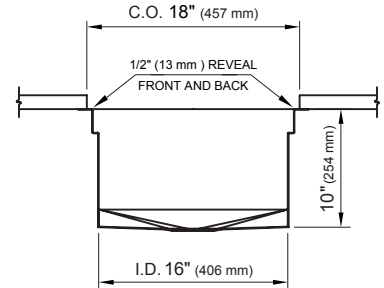
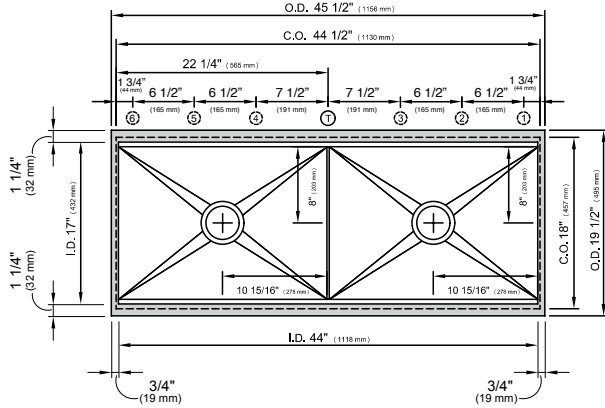

SUGGESTED GALLEY TAP AND TAP ACCESSORIES PLACEMENT GUIDE

(Recommendations are based on installing 3 or more Tap accessories)

Suggested maximum inside corner radius of countertop cutout 3/8"

- ① Galley Tap 1 3/8" min hole diameter (1 1/2" min hole diameter for fast water jet cut)
- ② Galley Soap Dispenser 1" min to 1 3/8" max hole diameter
- ③ Galley Deck Switch 1 3/8" min hole diameter or Galley Automatic Strainer Basket knob 1" min and 1 3/8" max hole diameter
- ④ Galley Hot & Cold Tap 1 3/8" min hole diameter (1 1/2" min hole diameter for fast water jet cut)

Center Tap hole diameters 2" behind cutout

Note: Galley Hot & Cold Tap requires a minimum 8" clearance to center if installed to the right of the Galley Tap

Note: For installation where the drain is on the left side, simply reverse placements of Tap and Tap Accessories

Countertop Cutout Plan

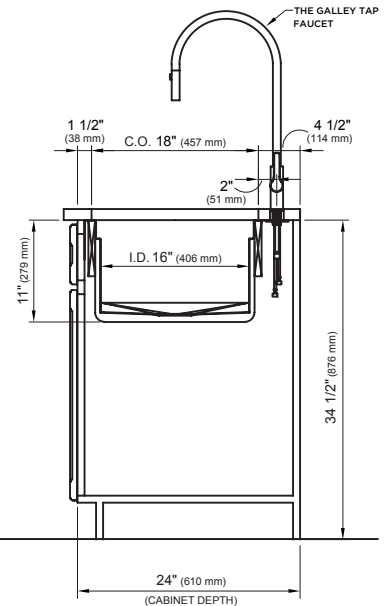
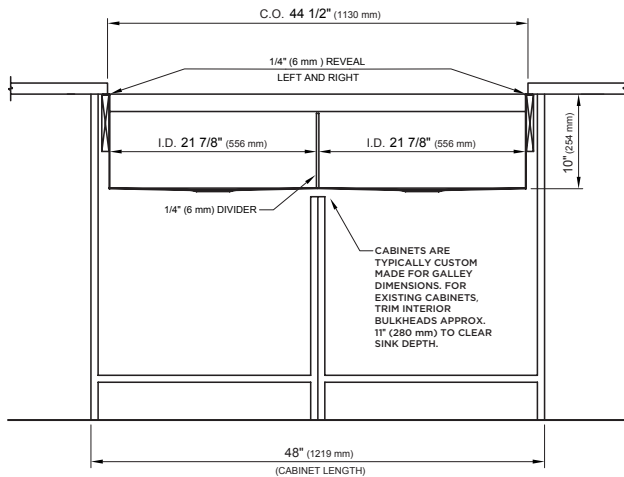

STAINLESS STEEL COMPLIANCE ASME A112. 19.3-2008/CSA B45.4-08

WE RESERVE THE RIGHT TO MAKE REVISIONS WITHOUT NOTICE IN THE DESIGN OF PRODUCTS OR IN PACKAGING UNLESS THIS RIGHT HAS SPECIFICALLY BEEN WAIVED AT THE TIME THE ORDER IS ACCEPTED.

DWG and DXF templates available on our website:

TheGalley.com/specifications

Questions? For additional assistance, please contact
The Galley's Customer Service Department at 800.375.4255