

IDEAL WASHSTATION™ 3 - SINGLE BOWL (IWA 3S)

SPECIFICATIONS & COUNTER TOP CUTOUT

SPECIFICATIONS

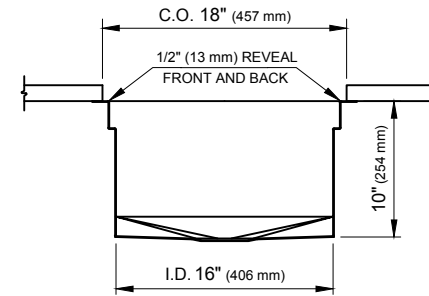
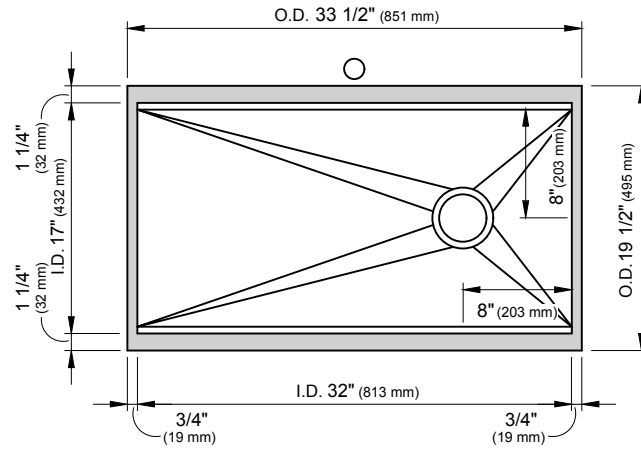

COUNTER TOP CUTOUT PLAN

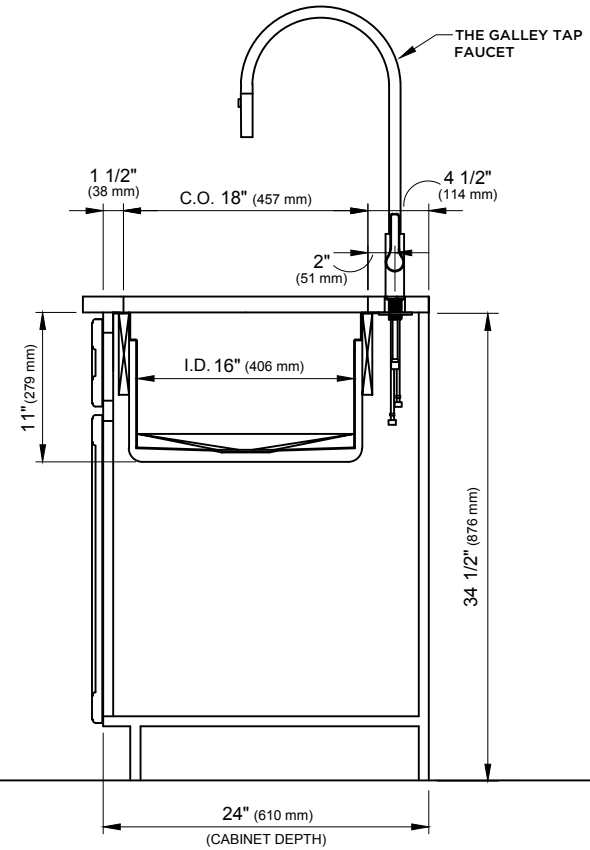
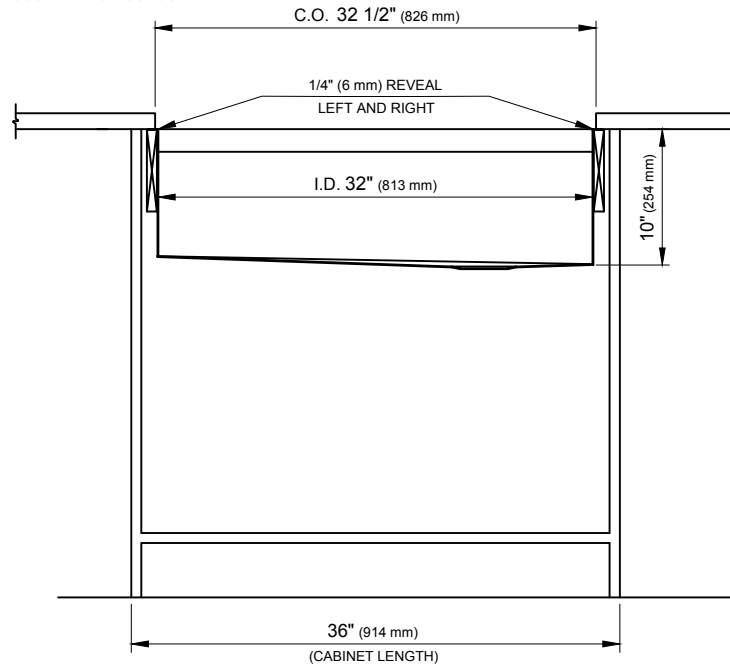

STAINLESS STEEL COMPLIANCE ASME A112. 19.3-2008/CSA B45.4-08

WE RESERVE THE RIGHT TO MAKE REVISIONS WITHOUT NOTICE IN THE DESIGN OF PRODUCTS OR IN PACKAGING UNLESS THIS RIGHT HAS SPECIFICALLY BEEN WAIVED AT THE TIME THE ORDER IS ACCEPTED.

DWG and DXF templates available on our website:
TheGalley.com/specifications

Questions? For additional assistance, please contact
The Galley's Customer Service Department at 800.375.4255