

Ideal Workstation. 3X4C

SPECIFICATIONS

IWS-3X4-C-WA



American Black Walnut

IWS-3X4-C-GT



Graphite Wood Composite

IWS-3X4-C-BA



Natural Golden Bamboo

IWS-3X4-C-GR



Exclusive Gray Resin*

IWS-3X4-C-WH



Designer White Resin*

Specifications

Single bowl
Users: 2 (Outside Corner), 1 (Inside Corner)
Culinary Tools included: Five
Galley Tap recommended: One
Outside dimensions: 32" x 44" x 19 1/2" x 10 5/16"
Interior dimensions: 30" x 42" x 17" x 10"
Countertop cutout: 30 3/4" x 42 3/4" x 18"
Basin area: 30" x 42" x 16"
Min. cabinet size: 36" x 48" or 90cm x 120cm

Basin (KSO-3X4-C-SS)

16GA 316L stainless steel indoor/outdoor
SilentArmor™ sound reduction technology
Angel finish
Three tier design
Star™ groove pattern
Side drain
Drain cover included
Limited Lifetime Warranty
Made in the USA
ASME A112.19.3/CSA B45.4 certified
cUPC™ certified

Customize Your Galley

Add 7-12" length
Add 1-6" length
Add 18" DryDock
Add 12" DryDock

9" depth
ThinTop™
WorkTop™
*Color coded labels available

Culinary Tools included (CKT-12)

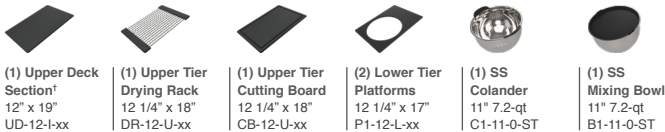

† The Upper Deck requires a 1/4" clearance below the surface of the countertop. If the countertop thickness is 3/4" or less, Walnut or Bamboo Upper Deck sections will not have the clearance to function above the Upper Tier Culinary Tools.

Upper Deck.

Cover set UD-4X3-3P-WA/GT/BA/GR/WH Walnut, Graphite, Bamboo, Gray or White Resin

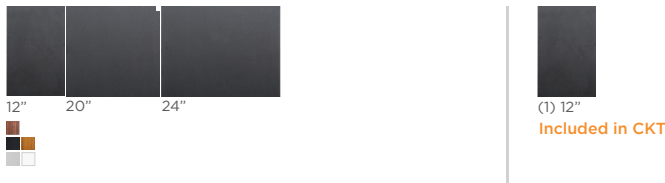

Sections Walnut, Graphite, Bamboo, Gray or White Resin



Recommended Basin Accessories & citrine.

Bottom Grate set BG-4X3-C-2-SS Stainless Steel

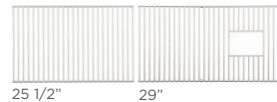

CIT-09-SS-C

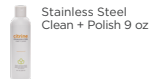

CIT-09-WD-C

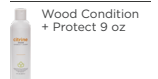

CIT-04-WD-B



Strainer M-DRN-MSS
Angel Finish 304 Stainless Steel



Disposal Strainer G-DRN-MSS
Angel Finish 304 Stainless Steel



Auto Strainer Angel Finish 304 Stainless Steel with Polished or Matte knob



A-DRN-MSS shown

Ideal Workstation. 3X4C

SPECIFICATIONS

Tap Hole Specifications

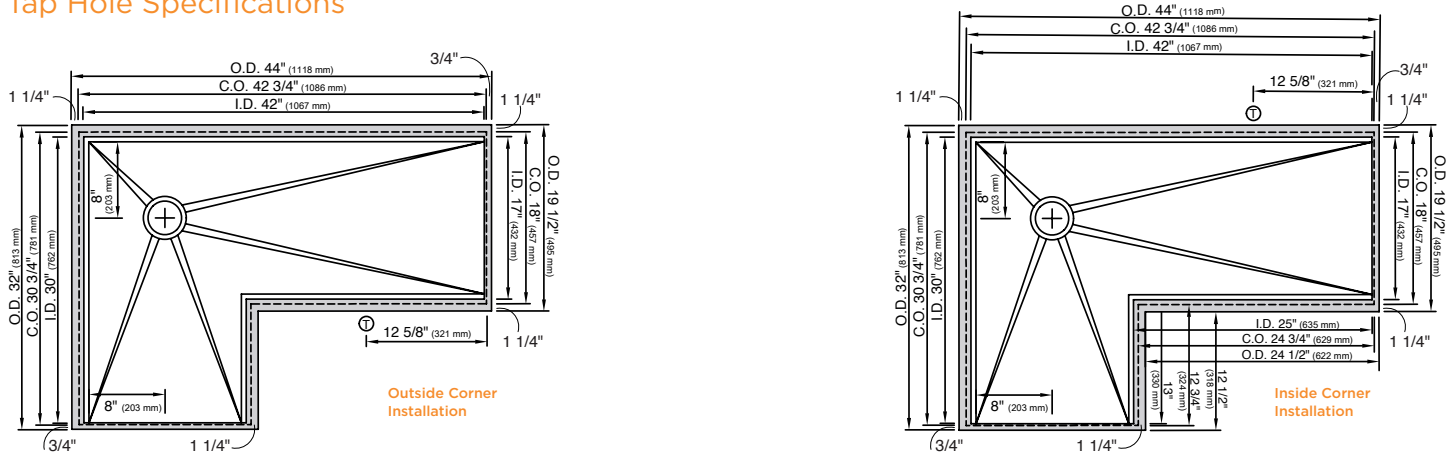

SUGGESTED GALLEY TAP PLACEMENT GUIDE

Suggested maximum inside corner radius of countertop cutout 3/8"

① Galley Tap 1 3/8" min to 1 1/2" max hole diameter

Center Tap hole diameters 2" behind cutout

Note: Galley Hot & Cold Tap requires a minimum 8" clearance to center if installed to the right of the Galley Tap

Note: For inner corner dimensions (O.D., C.O., I.D.) on Outside Corners, look to Inside Corner drawings

Call 800.375.4255 or email customer@thegalley.com for additional guidance on Tap and Tap Accessory placements

Countertop Cutout Plan

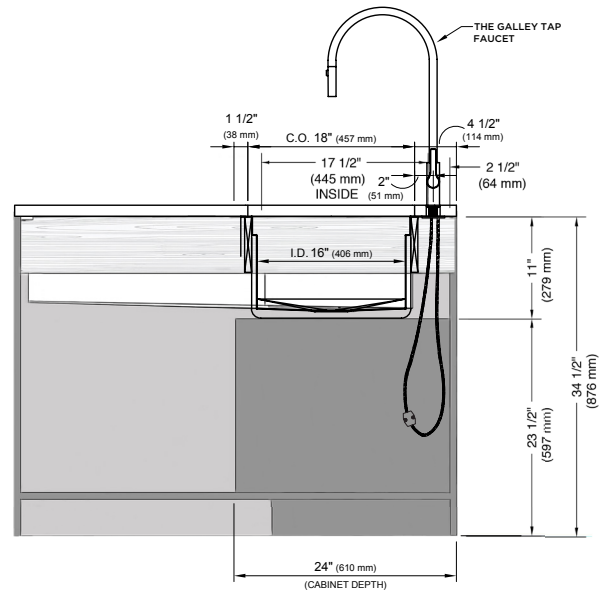
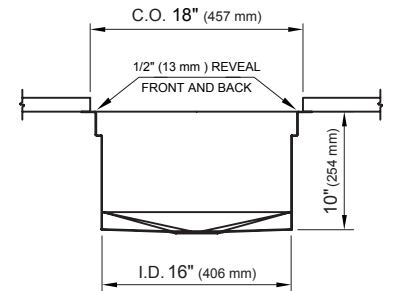
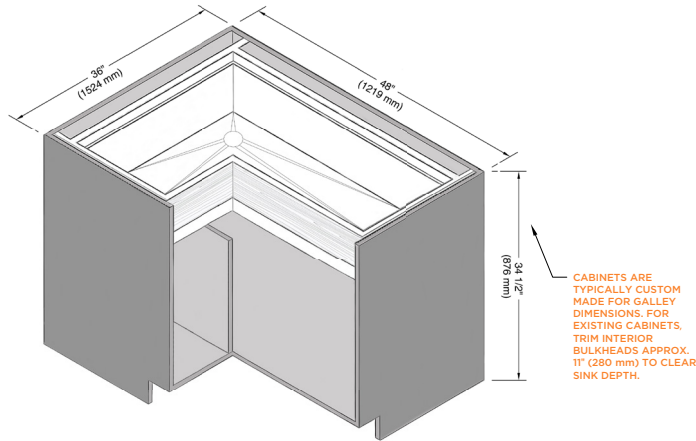

STAINLESS STEEL COMPLIANCE ASME A112. 19.3-2008/CSA B45.4-08

WE RESERVE THE RIGHT TO MAKE REVISIONS WITHOUT NOTICE IN THE DESIGN OF PRODUCTS OR IN PACKAGING UNLESS THIS RIGHT HAS SPECIFICALLY BEEN WAIVED AT THE TIME THE ORDER IS ACCEPTED.

DWG and DXF templates available on our website:

TheGalley.com/specification-library

Questions? For additional assistance, please contact
The Galley's Customer Care Department at 800.375.4255